

Research Journal of Pharmaceutical, Biological and Chemical Sciences

Injection Rate Shaping with Possibilities of Conventional Design Common Rail System.

Leonid Vadimovich Grekhov^{1*}, Yuri Evgen'evich Dragan²,
Alexandr Alexandrovich Denisov¹, and Egor Evgen'evich Starkov¹.

¹Bauman Moscow State Technical University, 2-nd Baumanskaya, 5, Moscow, 105005, Russia.

²Vladimir State University, Gorkiy Street, 87, Vladimir, 600000, Russia.

ABSTRACT

Significant toxic components emission reduction and fuel consumption reduction are main drivers which lead to design requirements and fuel injection systems operation revision. Required injection characteristic providing is one of the most important challenging requirements for fuel injection systems. Injection characteristic requirements got by diesel engine combustion process optimization are presented in this article; main strategies for injection characteristic for low-toxic diesel engines of different dimensions forming are analyzed and examined. Ways for injection characteristic organization by means of conventional Common Rail systems were investigated. The most efficient way allowing to organize stepped injection characteristic leading edge is using of waves phenomena in high pressure line.

Keywords: Low-Emission Diesel Engine, Combustion Process, Fuel Injection System, Common Rail System, Design, Possibilities, Injection Rate Shaping.

**Corresponding author*

INTRODUCTION

Diesel engines play a key role in the transportation energy sector of any developed country; their parameters and characteristics largely determine the technical level of the final object. Due to the achieved level of environmental performance and energy efficiency, today the diesel engine is the most popular and indispensable type of power unit for trains, automotive and special equipment.

To date, the development of modern high-speed and medium-speed diesel engines sets other tasks than a few decades ago. It is simultaneously required to ensure both increasing in capacity and reducing in fuel consumption, as well as low emissions of harmful substances from exhaust gases, particularly NOx and particulates. Legislative norms that limit emissions are constantly becoming tougher. In order to meet contemporary and future international environmental requirements, special measures are implemented to enhance the construction strength and rigidity, reduce friction losses and oil consumption. The optimization of fuel supply, mixture formation and combustion is carried out to reduce the emission of the harmful substances throughout the diesel operating mode.

In this connection, in the diesel engine combustion process optimization, more stringent requirements shall be satisfied for the fuel injection system (FIS). A validity of injection characteristics shaping is one of the most important requirements to the FIS [1].

Low-toxicity combustion process requirements to the injection characteristics shape

A study of the subcompact diesel engine with a displacement of about 0.5 l/cyl [2] (Figure 1) is an example of computational and experimental studies of the mixture formation and exhaust emission process, as well as obtaining the optimal injection characteristics shape, strategies of their shaping in the operational modes of the studied diesel engine.

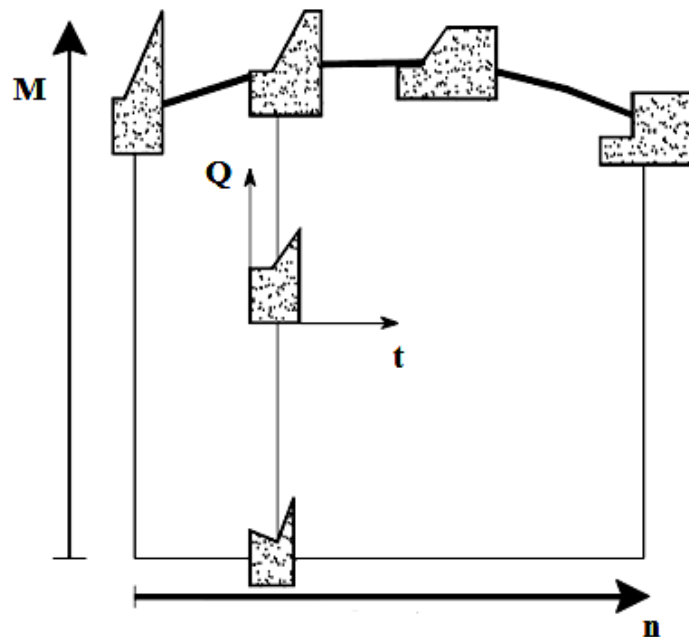

Fig. 1. The optimal injection characteristics in the operational modes of the subcompact diesel engine

The injection characteristics management on the studied diesel engine was carried out through the use of two HP pumps and the control device, ensuring their consistent switching on. This operation was carried out before the inception of the first commercial batch of the common rail systems, construction of which has now become a conventional one. However, the resulting effect of a radical emission reduction allows us to indicate the importance of the discussed requirements for the injection characteristics shaping and management, which are reasonably required for the modern common rail systems (Figure 2).

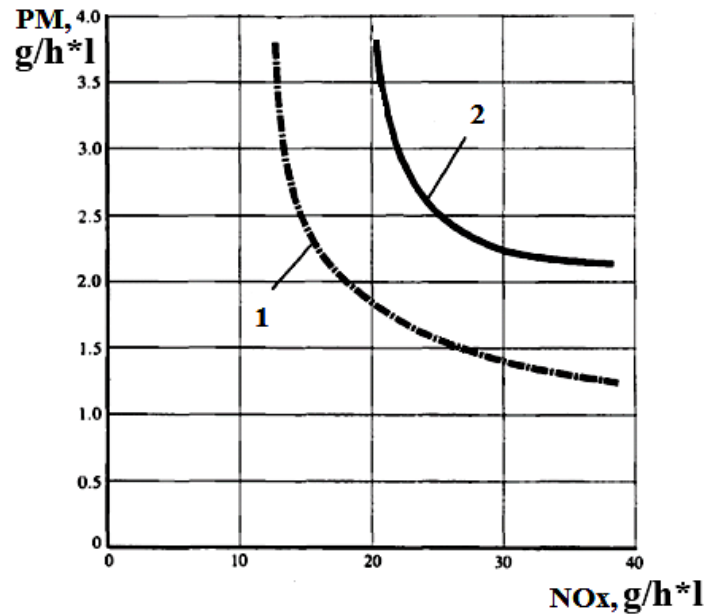

Fig. 2. The emission parameters of the studied subcompact diesel engine with different common rail systems: 1 – with the injection characteristics shaping; 2 –mechanic fuel injection system of conventional design.

The optimization computational results of the combustion process, which were conducted for medium-speed diesel engines at the Bauman Moscow State University [3], allowed us to formulate the requirements for the main injection shape. Figure 3 illustrates the optimum injection characteristics obtained for the promising Russian diesel engine D500 (12 cylinders, cylinder bore 265 mm, piston stroke 310 mm) at the rated mode in the optimization of its parameters for compliance with the exhaust emissions standards Stage-IIIB ($NO_x + CH \leq 4.0 \text{ g/kW}\cdot\text{h}$; $P_m \leq 0.025 \text{ g/kW}\cdot\text{h}$).

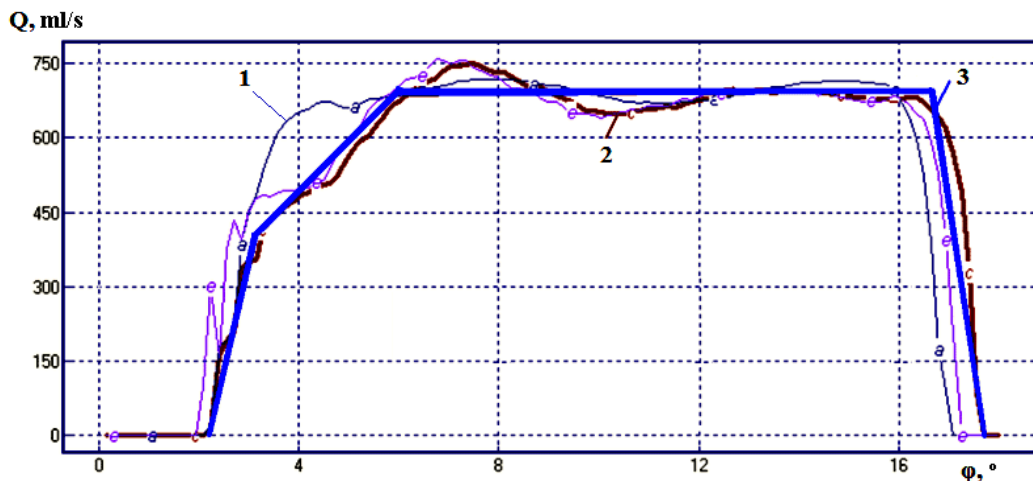

Fig 3. The injection characteristics on the example of optimizing of the promising Russian diesel engine D500 at full power for the exhaust emission standards Stage-IIIB: 1 – conventional design common rail system; 2 – optimized fuel injection system; 3 – optimal injection characteristics profile.

To reduce the exhaust emission, FEV Company members [4] proposed a strategy for the injection characteristics shaping based on the common rail system with a maximum injection pressure of 200...250 MPa, see Figure 4. Thus, in the medium load conditions, the pre-injection and main injection are necessary to be organized with varying inclination degrees of the front edge. At high load conditions, the graduated front edge is recommended for characteristics with different length of steps and afterinjection for post-combustion of soot. All this leads to a decrease in the exhaust emissions and the preservation of energy efficiency indicators.

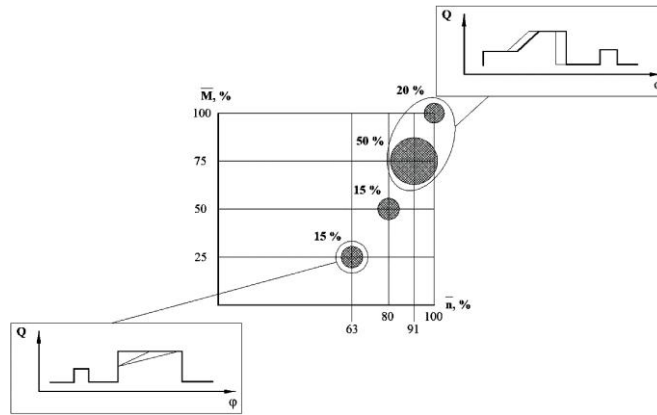

Fig.4. The injection characteristics shaping strategy in the medium-speed diesel engine

Thus, the following requirements have been identified to the shape of the main injection front edge. In the beginning of the main injection, rapid flow rate growth is due to the fact that in the beginning of injection large droplets shall not be formed, despite the fact that more time is given for their evaporation and combustion. . The subsequent slow flow rate growth is necessary to reduce the combustion hardness. Otherwise, during the combustion hold period, a large amount of fuel is supplied, the dynamic factor raises and increases the pressure in the cylinder, as well as loads on the engine crank mechanism and NOx emission.

Injection characteristics shaping methods of the conventional design common rail system

Object

The conventional design injector is an injector with a so-called throttle control, which is implemented under the scheme illustrated in Figure 5. Such fuel equipment appeared in series production in 1997 [5-6], and remains the most popular. The injector has a throttle control by a control plunger. When opening Control Valve 14, the fuel is discharged from the control chamber, the pressure decreases in the chamber. Thus, the fuel supply to an injector chamber from accumulator 5 via High Pressure Pipe 1 and Injector Channel 7 causes needle lifting and injection of fuel into the cylinder. The supply termination is provided by the closing of Control Valve 14. The pressure in the control chamber rises due to admission of fuel through Orifice 13 and acts on the control plunger. The difference between the squares of the control plunger and needle causes the acceleration of its closure.

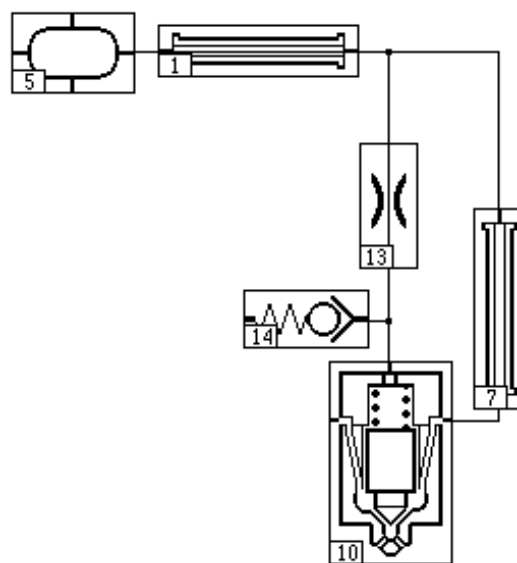

Fig.5. Functional diagram of the conventional design injector and high pressure line: 1 – HP Pipe; 5 – Fuel Accumulator; 7 – Injector Channel; 10 – Nozzle; 13 – Input Orifice; 14 – Control Valve.

The electronically controlled Common Rail Systems (CRS) are the most versatile fuel systems for diesel engines for various purposes. Unlike direct action systems, including those having full electronic control systems, the CRs have two undeniable advantages in terms of creating the low-emission diesel engines: they provide the optimum injection pressure control and significantly better control of the injection characteristics. If the first issue has been solved and has no problems, the solution to the second problem remains problematic and is the subject of this study, especially for main injection shape control at the multiple one (or at the single, one-time). The urgency of the injection characteristics shaping issue is due to the fact that the multiple injection is not possible at the rated and high load modes. Therefore, a problem of controlling the front edge of a single injection is particularly acute.

Combination of inlet and outlet cross-sections of orifices

Many settlement and optimization studies of working processes in the common rail fuel injection systems conducted by the authors have revealed the impact of combinations of Orifices 13 and 14 (Figure 5) on the injection characteristics shape (injection profile). We consider an example of an injector with uncompensated ball valve with the geometrical orifice cross section of 1.0045 mm^2 , when using the pressure of 200 MPa in the accumulator in the rated mode. Terms of the calculation are referred to the medium-speed diesels with rated crankshaft speed of the 1000 min^{-1} , cycle fuel mass of 1.5 g. Figure 6 shows the injection characteristics for various combinations of sections of orifices 13 and 14 of the injector. These values are close to the maximum possible ones; with a further difference increase, their injector does not open or close.

Obviously, for a small section of input orifice 13, the steep front edge and sloping rear edge is the worst option in terms of the low emission engine combustion process. At the same time, however, the best (lowest) values are achieved for one of the injector optimality criteria, such as the control fuel consumption. This confirms that there is no single optimality criteria for the injector.

In general, it can be noted that the selection of the orifices cross-sections not significantly affects the injection edge steepness. The choice of these sections is ruled by the following requirements: the injector manageability preserving, performance and requirements of the multiple injection organization, minimally stable cycle fuel mass, as well as minimal fuel consumption for the control, as well as a maximum of the injection pressure. Thus, the control chamber orifices cross-sectional areas cannot be an effective way to shape injection characteristics.

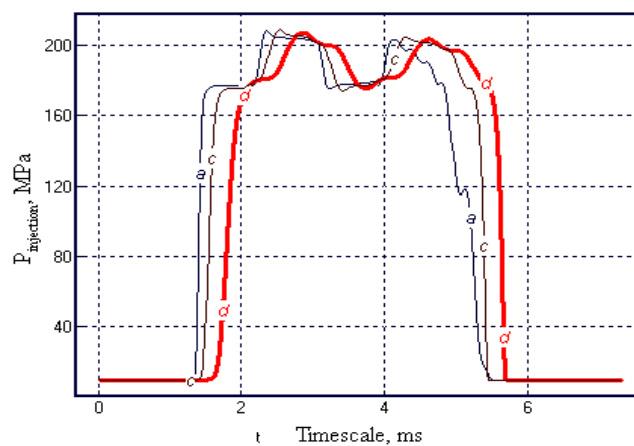

Figure 6. The injection characteristics for various combinations of the injector control chamber orifices: a – $\mu F_{13} = 0.03 \text{ mm}^2$, $\mu F_{14} = 1.0 \text{ mm}^2$; c – $\mu F_{13} = 0.18 \text{ mm}^2$, $\mu F_{14} = 1.0 \text{ mm}^2$; d (thick graph) – $\mu F_{13} = 0.18 \text{ mm}^2$, $\mu F_{14} = 0.33 \text{ mm}^2$.

Wave processes in the high pressure line

Effect of feed pipe diameter.

The only effective way of active front edge shaping of the injection characteristics is the organization of a special wave process. This method is justified and studied in the researches of the Bauman Moscow State

Technical University [7]. In addition to the possibility of organizing a sloping front edge, it allows us to preserve the injection pressure, and even work with a maximum injection pressure, even more than the accumulator pressure. The injector dead volumes minimization is a necessary condition for wave effects existence, as it is at the direct acting FIE. The injector dead volume was reduced to 500 mm³. Figure 7 illustrates the effect of the different pipe diameters.

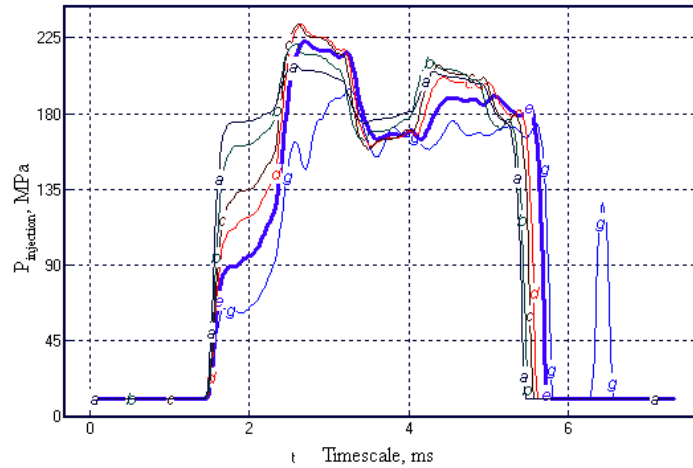

Fig. 7. The injection characteristics with the pipe length of 630 mm and different diameters: a – 7 mm, b – 5 mm, c – 3.5 mm, d – 3 mm, e (thick graph) – 2.5 mm, g – 2 mm.

The effect is a change in the amplitude of the first front edge step of the injection characteristics. Excessive intensification may cause afterinjection (curve g for d = 2 mm). It can probably be prevented, but most likely, the wave effect has its rational value.

Effect of feed pipe length.

Of course, the wave parameters depends on the pipe length. This is illustrated in Figure 8.

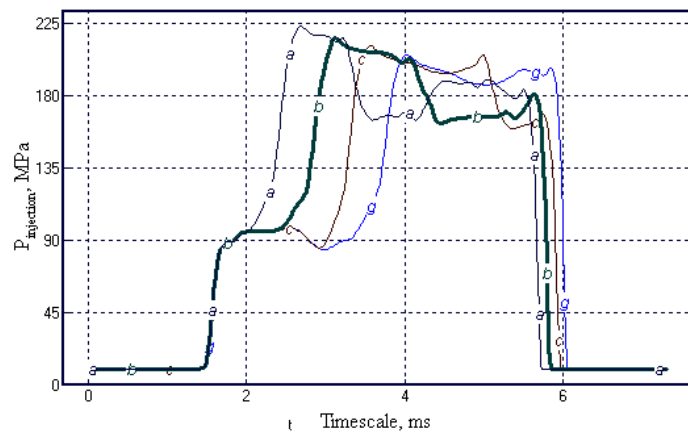

Fig. 8. The injection characteristics with the pipe diameter of 2.5 mm and different lengths: j – 630 mm, e (thick graph) – 950 mm, d – 1,300 mm, h – 1,600 mm.

Effect of feed pipe is in the displacement between the first and second segments of the front edge of the injection characteristics.

Obviously, the pipe length was chosen historically out of layout considerations. However, the CRS allows us to vary this parameter within wide limits and does not impose severe restrictions on its optimum value. In practical terms, the restriction is imposed due to limited range of standard high-pressure pipes.

Injector elements deformation

In recent years, the maximum injection pressure has increased over the previous 50...60 years by 3...5 times in comparison with the usual one, and to 2015 reached the level of 250 MPa in serial production. In these circumstances, the Common Rail injectors deformation effect on their features became an urgent question.

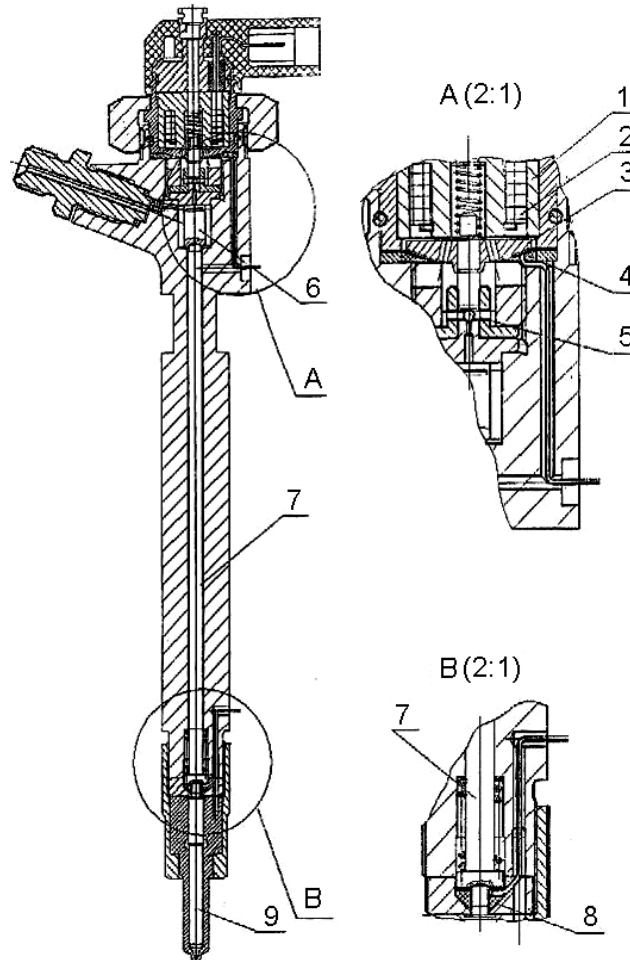

Fig.9. Injector with control valve (A) and needle (B) motion sensors: 1 – core; 2 – anchor; 3 – anchor; 4 – valve lift sensor; 5 – ball control valve; 6 – control plunger; 7 – control plunger post; 8 – needle lift sensor; 9 – needle.

For the first time, the anomalous behavior of injectors of the common rail system were seen during the joint study with the Bauman Moscow State Technical University, the study for creating an experimental common rail system [8-9]. The control valve motion sensors and injector needles were installed in the experimental CRS injector (Figure 9). In modern point of view, the injector itself is typical, close to the most popular automotive designs. It is important that they are generally very elongated in length and are provided with control plunger, which represents long small section post with the plunger at the top. It is important because during operation in the periods between injections, the needle is pressured from the bottom, and the control plunger is pressured from the top by the fuel pressure equal to the pressure in the accumulator (P_{acc}). Due to this, these parts having small cross section, are significantly compressed (at a pressure of 180 MPa – 0.1 mm, which is comparable with a geometric needle lift). Injector body parts are also deformed, but in the direction of stretching. Given the thickness of the modern injectors, it is clear that this cannot be neglected.

The injector elements motion sensors allowed us to record the actual lift of the valve and needle (Figure 10), and a comparison with the geometric values in real sample of the injector allowed to evaluate the injector elements deformation. During the processing of the results of carried out tests, we revealed that the

deformation of the plunger post is essential, even at relatively low operating pressures and undoubtedly depends on its value (Figure 11).

Because the compressibility of the fuel is shown in compression of fuel in a chamber, the physical entities in terms of their impact on the process of fuel injection is close to the deformation of the chamber (it is shown simultaneously and they together influence the process and accumulate the potential energy of the fuel compression and the cavity walls deformation). So their overall impact has been often assessed as an equivalent compressibility coefficient [7, 10].

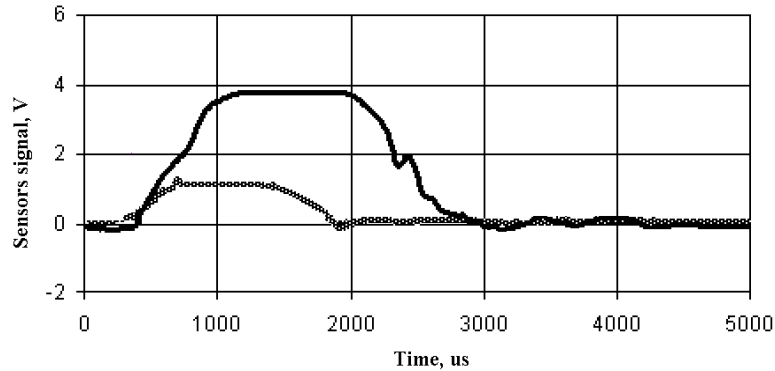

Fig.10. The injector control valve and needle lifting at a boosting voltage of 150 V, a demagnetization voltage of 100 V, retention time of 0.8 ms, the pressure in the accumulator of 80 MPa, and cycle fuel volume of 56.7 mm³.

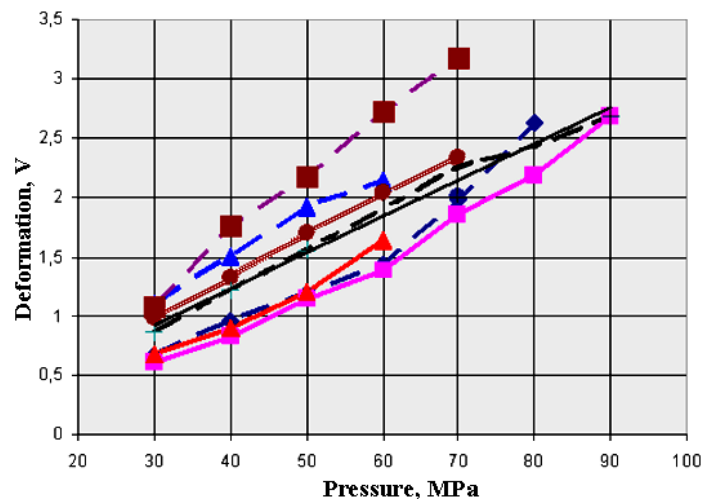

Fig. 11. The control plunger post deformation in function of the accumulator pressure for various embodiments of the injector.

Thus, the increase in volume of the control chamber is possible to be calculated with the corresponding change in the nature of the processes [9].

However, it is so, if the concept of equivalent compressibility coefficient is not always accurate. For example, it has never caused objections in Rothrock's formula for the fuel compressibility coefficient estimating in pliable infinitely long pipe due to the simplicity and accuracy of the pipe deformation allowance [7]. Unfortunately, quantification of the equivalent compressibility coefficient becomes a problem for cavities of complex geometry. The following is also important: longitudinal compliance of the injector is also manifested in the form of other effects. Thus, the effect of the post deformation is not the same in the control chambers of different volume and shape. As it is described below, the fact that the actual needle lift increases is also significant.

Thus, there is need to address the compliance of the injector parts for the most important influences on the fuel supply process, and the process model shall be easy to fit into the overall hydrodynamic fuel supply model [7].

Now we specify the physical characteristics of the process. When there is high pressure in the injector, needle and control plunger are compressed, and the body parts are stretched. As a result, the volume of the control chamber is increased in accordance with the amount of the longitudinal deformations. At the same time, the potential maximum lift of the needle increases by the same amount.

During the fuel injection, the control chamber is partially discharged, but in a chamber below needle (injector chamber), there is nearly the same high pressure, which is instant and continuously evaluated in the calculation of the chamber pressure. The top compressive force reduction of the pressure in the control chamber is compensated by a mechanical reaction, such as a force from the retainer. Therefore, the control plunger cannot preserve the initial formed state and is compressed. Similarly, the body parts are in a state of tension. A hydraulic force can be logically considered as a force causing a deformation in such position; this force lifts the needle without locking spring effort force.

Thus, the injector parts compliance leads to changes in the volume of the control chamber and the actual maximum lift of the needle. These values are not consistent, and depend on both the P_{acc} , and changing pressures in the injector chambers, i.e., time.

Mathematical model of the fuel supply, including the injector is known, is described in [7] with significant updates. Here, we dwell only on its characteristics, taking into account the longitudinal compliance of the injector parts. Because the sound speed in steel exceeds the sound speed in fuel (more than 5,000 m/s), and the post length is not more than 0.1 m, and also due to the relatively slow change in pressure in the control chamber, the opinion to account for unsteadiness of the post disturbances propagation looks to be completely unnecessary. It also unnecessarily slows the calculation.

Given the opposite effect of the temperature and pressure on the fuel density, using the volume balance equations satisfies precision requirements of practical calculations until recently. In general, for any cavity with volume of V_i , the volume balance equation has the following form:

$$\frac{dP_i}{dt} = \frac{1}{V_i \beta_i^{eff}} \left[\sum Q_{i-k} + \sum U_{i-j} f_j + \sum \frac{dV_{i-n}}{dt} \right], \quad (1)$$

where: $\beta_i^{eff} = \beta_i^{fuel} + k_{def}$; k_{def} - the cavity deformation coefficient; Q_{i-k} - leakage to (from) k-th cavity; dV_{i-n} - volume change under the action of moving the n-th element; U_{i-j} - fuel flow velocity from (into) j-th channel.

So, for the control chamber above needle or control plunger it usually looks like as follows:

$$\frac{dP_{cc}}{dt} = \frac{1}{V_n \beta_n^{eff}} \left[\mu_{jet} f_{jet} \sqrt{\frac{2}{\rho} (P_n - P_{cc})} - Q_{leak}^{mult} - \mu_{val} f_{val} \sqrt{\frac{2}{\rho} (P_{cc} - P_{flow})} + f_{plung} \frac{dC_n}{dt} \right]; \quad (2)$$

There $\mu_{orifice} f_{orifice}$ - the effective cross-section of the input orifice, $\mu_{val} f_{val}$ - the effective cross-section of the control valve, P_{cc} - the pressure in the control chamber, P_n - pressure in the injector inlet, $Q_{multleak}$ - leakage mass flow through the control plunger clearance, C_n - needle speed.

Given the existence of longitudinal compliance of the injector parts, which leads to an additional shift of the control plunger with respect to the control chamber, which increases the chamber volume by an amount $f_{mult} \cdot \Delta x_n^{def}$, causing inequality between the control plunger and needle speed, the equation (2) has the following form:

$$\frac{dP_{cc}}{dt} = \frac{1}{V_n^{def} \beta_n^{eff}} \left[\mu_{jet} f_{jet} \sqrt{\frac{2}{\rho} (P_n - P_{cc})} - Q_{leak}^{plung} - \mu_{val} f_{val} \sqrt{\frac{2}{\rho} (P_{cc} - P_{flow})} + f_{plung} \frac{dC_{plung}}{dt} \right]; \quad (3)$$

Where: $V_n^{def} = V_n^{inact} - f_{plung} \cdot (x_n - x_n^{def})$; (4)

$$x_n^{def} = x_n + \Delta x_n^{def} = x_n + S_{compr} \cdot k_{comp} / E_{steel};$$

$$(x_n^{def})^{max} = (x_n)^{max} + \Delta x_n^{def} = (x_n)^{max} + S_{compr} \cdot k_{comp} / E_{steel}; \quad (5)$$

The compressive force applied to the control plunger S_{com} can be calculated as follows:

$$S_{compr} = P_{cc} \cdot f_{plung} \quad \text{for the needle on the seat position } x_n = 0;$$

$$S_{compr} = P_{dist} \cdot f_n^{diff} + P_{inj} \cdot (f_n - f_n^{diff}) \quad \text{for the needle out of the seat position } x_n > 0.$$

k_{comp} is generally not only the compliance of the post itself, like most non-rigid part, but the reduced compliance, reflecting the non-rigidity of the whole Body-Needle-Post-Plunger System. If the k_{comp} is easy to be calculated for the post as a length ratio to its cross section, for the said deformable system, total compliance can be determined as follows:

$$k_{comp} = \sum_i (k_{comp})_i = \sum_k \left(\frac{l_i}{f_i} \right). \quad (6)$$

For more accurate k_{comp} assessment than by Formula 6, deformation task can be solved using finite element method. Thus, now using Formula 4 we take into account the change in volume of the control chamber, and using Formula 5, we consider an increase in needle lift.

Let us consider the influence of the injector longitudinal deformation on its operation. Let us consider an example of a well-known injector with the unbalanced ball valve by R. Bosch Company with the injector nozzles of 5×0.182 mm. When using the pressure in the accumulator of 135 MPa in the rated mode, as it was in the first models of the CR systems, the rise of the needle varies according to Figure 12. The calculation terms are referred to the diesel engine with the rated crankshaft speed of $4,200 \text{ min}^{-1}$, cycle fuel mass of 60 mg. For the current Option A, we take an example of longitudinal compliance absence, $k_{comp} = 0$. Option B reflects the actual value of the injector total longitudinal compliance $k_{comp} = 9.5 \text{ mm}^{-1}$. Option C corresponds to double compliance $k_{comp} = 19 \text{ mm}^{-1}$.

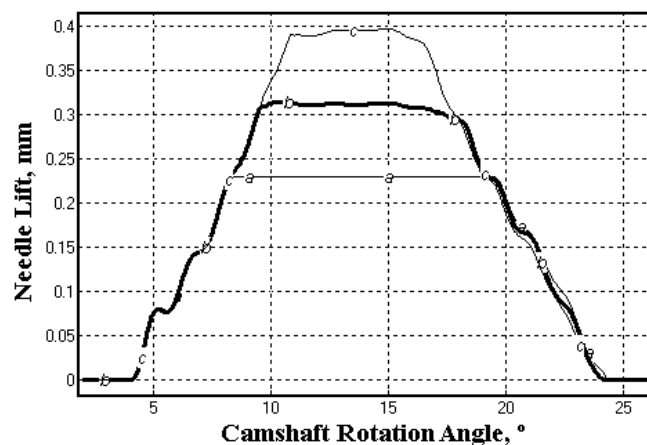

Fig.12. The dependence of the actual R. Bosch injector needle lift at $P_{acc} = 135$ MPa and various compliance coefficients is the following: A; B and C correspond to $k_{comp} = 0$; 9.5 and 19 mm^{-1} .

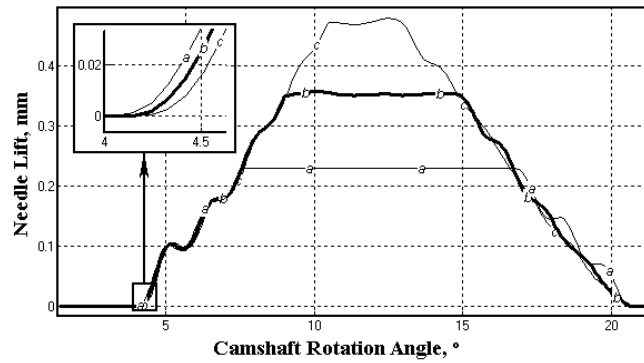

Fig.13. The dependence of the actual R.Bosch injector needle lift at $P_{acc} = 200$ MPa and various compliance coefficients is the following: A; B and C correspond $k_{comp} = 0; 9.5$ and 19 mm^{-1} .

The behavior of the injector on the present level of pressure is also interesting. Today, it is usually 180 MPa and more. With some advance for analysis, we examine the level of 200 MPa (see Figures 13 and 14).

Basing on the illustrations, we can come to the following conclusions. The longitudinal compliance is manifested primarily in the needle lift increasing. In the considered cases, P_{acc} is 135 and 200 MPa, it has increased by 35 and 38%.

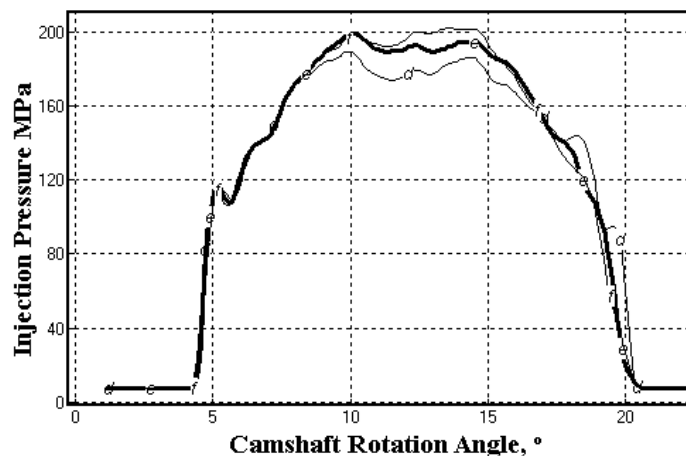

Fig.14. The dependence of the actual R. Bosch injector pressure at $P_{acc} = 200$ MPa and various compliance coefficients is the following: $k_{comp} = 0; 9.5$ and 19 mm^{-1} .

Process change in the control chamber associated with a change in its volume, is not so significant. We can explain it as follows: the deformation increases the volume of the control chamber in the present case by the maximum of 5-6%, and the volume at small values not so significantly affects the injection parameters. Thus, the injection pressure is increased somewhat in view of deformations. This is due to the large cross-section of the nozzle cone and lower hydraulic losses therein.

The injection phase shift is more significant under the strain. Even in the experimental systems [8], it was noted that the needle lifting is late with respect to the expected one. It is important when developing the control programs and in diagnostics. Such latency depends on both the design features of the injector and P_{acc} , i.e. the diesel engine operation mode. In the above cases, the delay ranged from 0.04 to 0.14 degrees of the camshaft rotation (3...11 μs).

Thus, on the one hand, the injector longitudinal deformation of the CR systems deforms the injection characteristics and fuel injection phases. On the other hand, it shall be taken into account in the mathematical models used in the injector design process, and its effects can be minimized.

DISCUSSION

Today, there are more adaptive designs of the CR injectors, which allow us to form the necessary injection characteristics regardless of the engine operation mode, for example, the Bosch CRSN4.2 System [7]. Typically, such systems have a pressure amplifier and additional control valve. However, the cost of such fuel systems significantly exceeds the cost of the conventional design CR systems, it is less technological effective, requires a high level of production, as well as fuel filtration and transportation. In this regard, the presented methods of the injection characteristics shaping are not less important, although they are tough set, but to the right direction.

CONCLUSION

The analyzed methods of the injection characteristics shaping are achieved by optimizing the conventional design CR injector. Thus, the recommendations for the injection characteristics shaping in the conventional design CR systems are the following:

- If the cross section of the injector inlet orifice (μF_{13}) reduces, the slope of the injection characteristics front edge increases, while the slope of the rear edge increases during the valve cross section μF_{14} reducing. The choice of these cross sections is ruled by the following requirements: the injector manageability preserving, response speed and requirements of the multiple injection organization, minimally stable cycle fuel amount, as well as minimal fuel consumption for the management, as well as a maximum of the injection pressure. Thus, the control chamber orifices cross section adjustment is not the only effective way to form injection characteristics shape.

An effective way of active injection characteristics front edge shaping is the organization of a special wave process. In addition to the possibility of organizing a sloping front edge, it allows us to preserve the injection pressure, and even work with a P_{inj}^{max} , which is more than the P_{acc} .

- The longitudinal deformation of the injector parts, which is the needle and control plunger compression, as well as the body parts tension, is a specific phenomenon in the common rail systems. Mostly a longitudinal strain occurs in the increasing needle lift. The value of the total longitudinal deformation is comparable to the needle lift. It increased the needle lift by 37...50% in the experimental injector and R. Bosch injector. The longitudinal deformation of the injector parts changes the injection characteristics by itself. In pair with special methods of needle movement separation into two distinct phases, it is possible to control the front edge of the injection characteristics.

ACKNOWLEDGMENTS

This research is financially supported by the Ministry of Education and Science of the Russian Federation by theme 2015-14-579-0052-002 "Development of innovative structures and means of computational studies of high-pressure fuel injection equipment with advanced technical parameters" (the universal code RFMEFI57715X0114).

REFERENCES

- [1] Grekhov, L.V., A.A. Denisov and E.E. Starkov, 2014. Requirements Justification for Fuel injection system, Energy-Efficient Low-Emission Diesel Engines. VSTU News, 6(18): 7-11. (In Russian).
- [3] Burgler, L., P.L. Herzog and P. Zelenka, 1992. Strategies to Meet US 1994/95 Diesel Engine Federal Emission Legislation for HSDI Diesel Engine Powered Vehicles. Proceedings of the Institution of Mechanical Engineers, Part D: Journal of Automobile Engineering, 1(206).
- [4] Kuleshov, A.S. and L.V. Grekhov, 2013. Multidimensional Optimization of DI Diesel Engine Process Using Multi-Zone Fuel Spray Combustion Model and Detailed Chemistry NO_x Formation Model. SAE Technical Paper, 2013-01-0882.
- [5] Wiartalla, A., L. Ruhkamp, T. Koerfer, *et al.*, 2010. Future Emission Demands for Ship and Locomotive Engines – Challenges, Concepts and Synergies from HD-Applications. In 26th CIMAC World Congress on Combustion Engine, Bergen, Paper No. 174, pp: 14.



- [6] Hoffmann, K.-H., K. Hummel and T. Maderstein, 1997. Das Common-Rail-Einspritzsystem – ein neues Kapitel der Deseleinspritz-Technik. *MTZ: Motortechnische Zeitschrift*, 10(58): 572-582.
- [7] Robert Bosch GmbH, 1998. Common Rail System for Passenger Car. Technische Unterrichtung. Stuttgart.
- [8] Grekhov, L.V., I.I. Gabitov and A.V. Negovora, 2013. Design, Calculation and Technical Service of Fuel Equipment of Modern Diesel Engines: Textbook. Moscow: Publishing House of the Legion Autodata. (In Russian).
- [9] Dragan, Yu.E., 2002. Experimental Studies of Injectors of High-Speed Car Engines Common Rail Systems. In Proceedings of the International Scientific and Practical Conference "The Advancement of Transportation Vehicles and Systems – 2002", Part 2, Volgograd. (In Russian).
- [10] Dragan, Yu.E., 2012. Analysis of Studies of Hydrodynamic Processes in the Diesel Engines Injectors. *Internal Combustion Engines*, 2: 3-7. (In Russian).
- [11] Astakhov, I.V., L.N. Golubkov, V.I. Trusov, *et al.*, 1990. Fuel Systems and Economical Diesel Engines. Moscow: Mechanical engineering, pp: 288. (In Russian).